

Aprilaire Model 1750 Dehumidifier Parts List

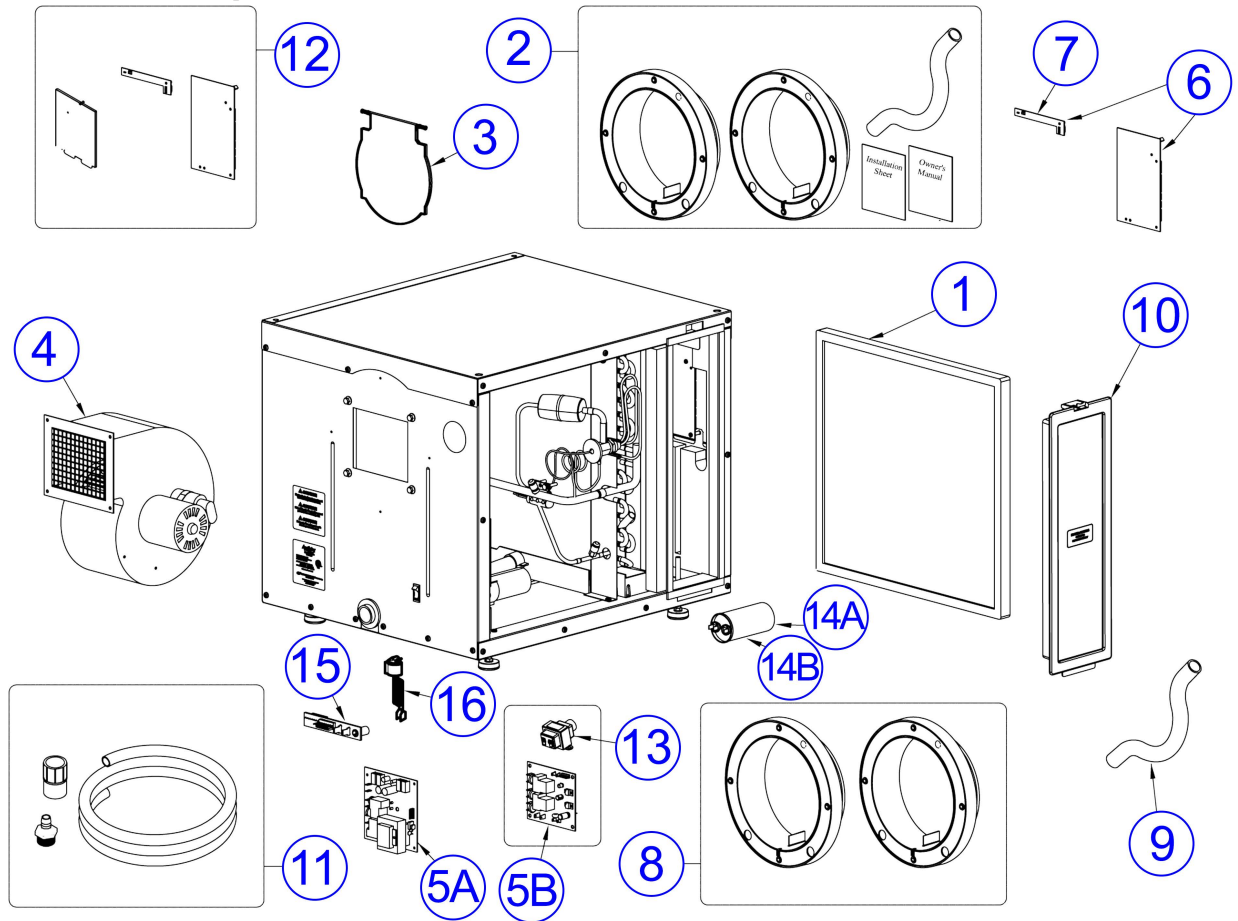

			Model 1700/1710/1720/1750/1770	
NO.	PART DESCRIPTION	QTY/CTN	PART NO.	
1	Filter	1		4510
2	Drain Trap/Collars/Manual	1		4843
3	Backflow Damper*	1		4918
4	Blower/Motor Assembly, 1710A/1750A and 1700/1710/1750	1		4515
	Blower/Motor Assembly, 1770A and 1720/1770	1		4646
5A	Power Supply Board			4517
5B	Power Supply Board (new style without integrated transformer)***			N/A
6A	Control Board Kit (includes control board and sensor board)		See Table 2 on Page 2	
6B	Control Board Kit, Compatible with Model 76 Control (includes control board and sensor board)			
7	Sensor Board	1		4752
8	Duct Collars	2		4751
9	Drain Trap and PVC Elbow	1		4842
10	Filter Door**	1		N/A
11	Condensate Drain Hose Assembly (included with Model 1710A only)	1		N/A
12	LED Control Door	1		4864
13	10 VA Transformer	1		5262
14A	Capacitor, 60MF (Model 1770A only)	1		N/A
14B	Capacitor, 55MF	1		N/A
15	Daughter Board	1		N/A
16	High Temperature Cutout Switch	1		N/A
17A	Compressor Overload Switch, 1710A/1750A	1		N/A
17B	Compressor Overload Switch, 1770A	1		N/A
OTHER PARTS				
	External Control			70
	Convertible Installation Kit (2-N/O 8" Damper, 2-N/C 8" Damper and Transformer)	1		4522
	Distributor and nozzle, 1710A/1750A	1		N/A
	Low Profile Condensate Pump (condensate pump with 20' condensate hose)	1		4856
	Living Space Duct Kit (25' of 8" insulated flex duct with 2 quick install grilles)	1		4857

*The backflow damper (Part No. 4918) is compatible with all Models 1730A, 1770A, but only with Model 1750A with Serial Numbers greater than 2610AA147015.

** Part 4861 is the blue/gray door; the almond colored doors are no longer available.

***Compatible with 4518 Control Board with DH terminal.

Table 2: Control board Kit Part Number (dependent upon method of control)

NO.	PART DESCRIPTION	Compatible With	QTY/CTN	PART NO.
6A	Control Board Kit	Model 70	1	4518
6B	Control Board Kit	No External Control	1	5353
6B	Control Board Kit	Models 75 or 76	1	5353